

Конт.	Цель	Цель	Конт.
11	S6	1	305
12	S3	S18	306
13		S19	2
14			4
15			5
16			6
17			7
18		SL	8
19		SP	9
20	S1		10

Конт.	Цель	Цель	Конт.
11	S2	1	319
12	S0	2	320
13		SB2	3
14		KM2	4
15			5
16		S9	6
17		S8	7
18		S5	8
19		S4	9
20			10

Конт.	Цель	Цель	Конт.
11			1
12			2
13			3
14			4
15			5
16			6
17			7
18			8
19			9
20			10

Конт.	Цель	Цель	Конт.
11			1
12			2
13			3
14			4
15			5
16			6
17			7
18			8
19			9
20			10

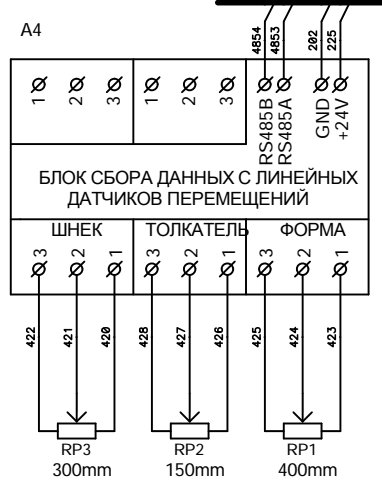

Конт.	Цель	Цель	Конт.
11			151
12			151
13			151
14			151
15			
16			
17			151
18			151
19			
20			10

Конт.	Цель	Цель	Конт.
603	10	YA9	20
604	9	YA20	19
605	8	YA11	18
606	7	YA10	17
607	6	YA12	16
608	5	YA18	15
609	4	YA4	14
	3		13
611	2	YA8	12
	1		11

Конт.	Цель	Цель	Конт.
617	10	YA7	20
618	9	KV2	19
619	8	EL	18
620	7	HA1	17
621	6	YA17	16
	5		15
623	4	YA23	14
	3		13
625	2	AIR1	12
626	1	AIR2	11

Конт.	Цель	Цель	Конт.
631	10	YA13	20
632	9	YA14	19
633	8	YA15	18
634	7	YA16	17
	6		16
	5		15
	4		14
	3		13
	2		12
	1		11

Конт.	Цель	Цель	Конт.
202	10	+24V	20
	9	GND	19
	8		18
	7		17
	6		16
	5		15
	4		14
	3		13
4852	2	RS485B	12
4851	1	RS485A	11

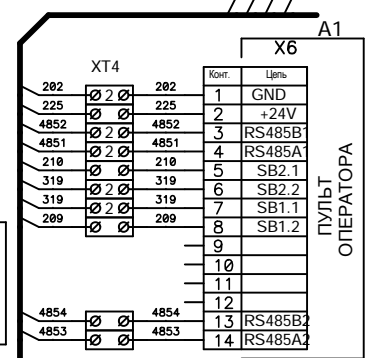
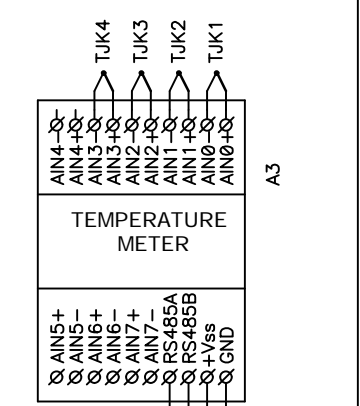
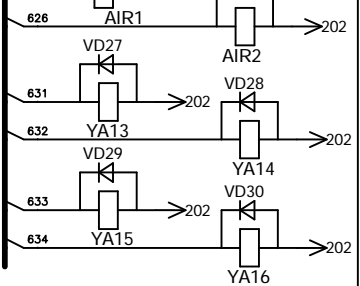
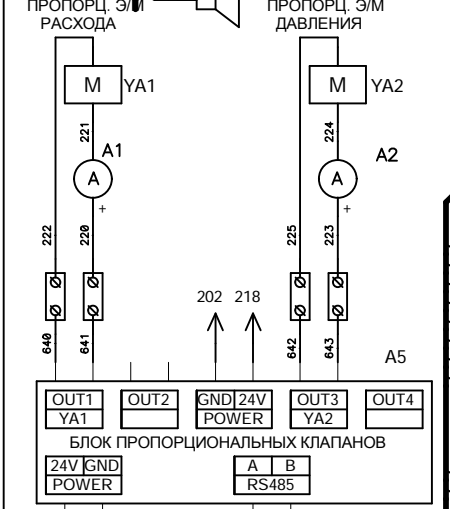
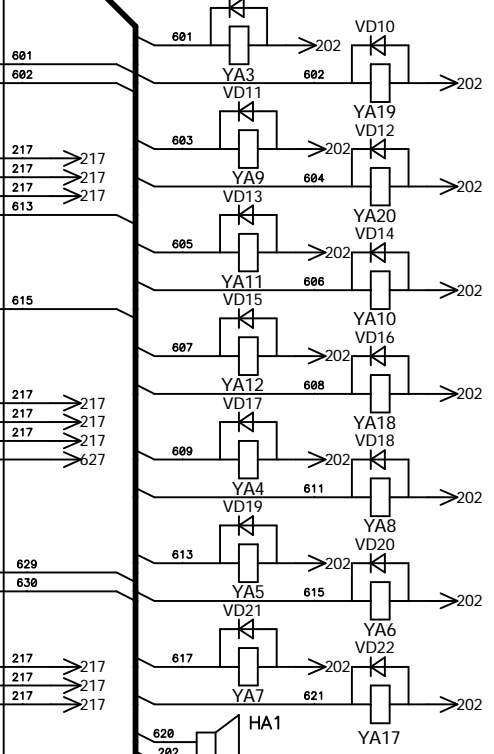

Клеммная колодка шкафа управления

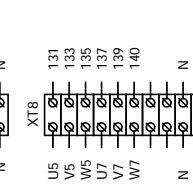
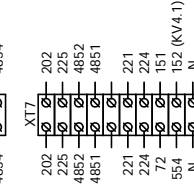
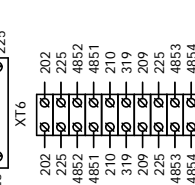
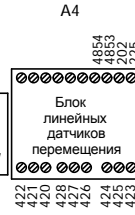
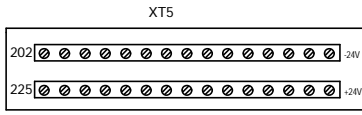
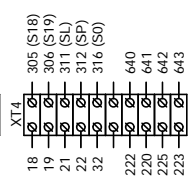
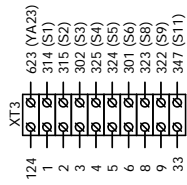
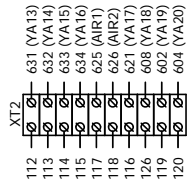
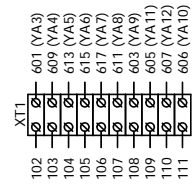

ДАТЧИК ОБОРОТОВ ШНЕКА

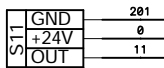

К ЭЛЕКТРОМАГНИТАМ

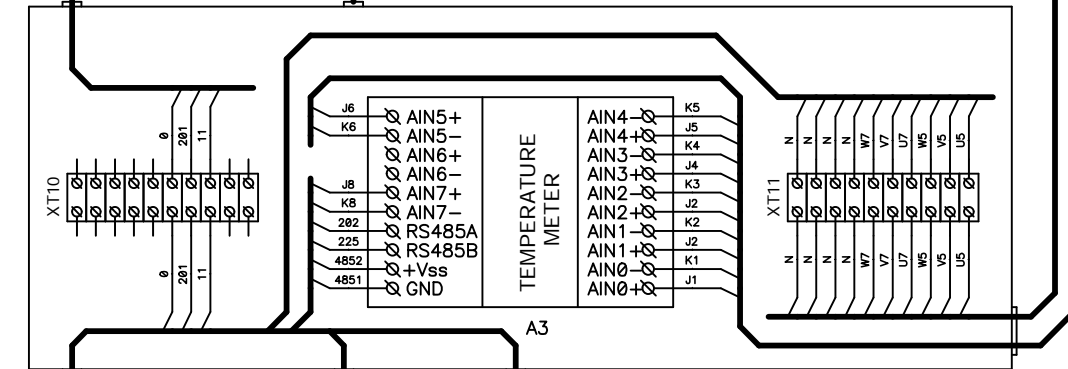

В силовой  
шкафу управления

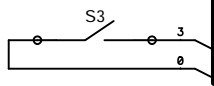

ДАТЧИК ПЕРЕДНЕГО  
ПОЛОЖЕНИЯ СОПЛА

Линейка шнека

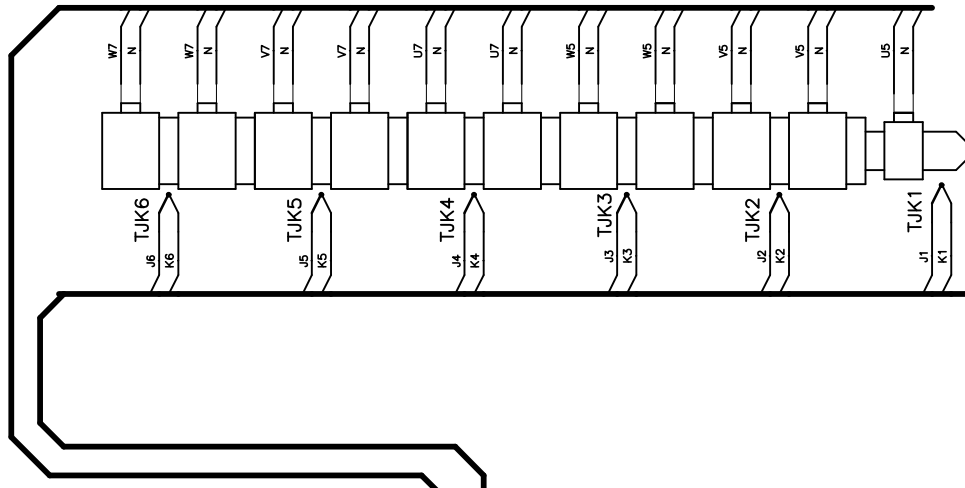

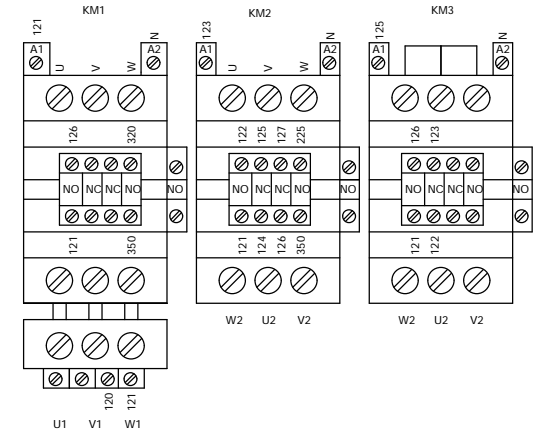
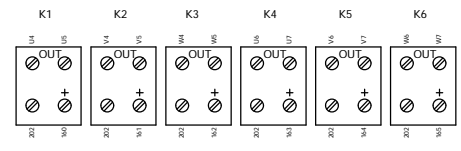
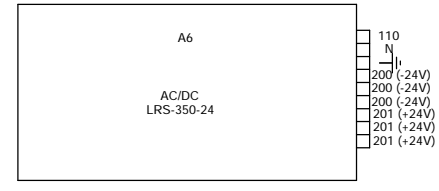
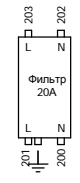
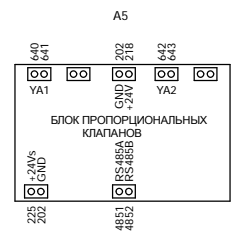
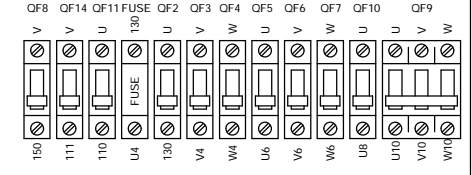
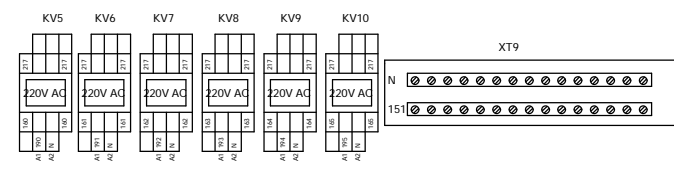
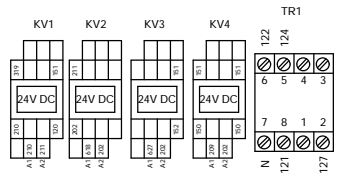
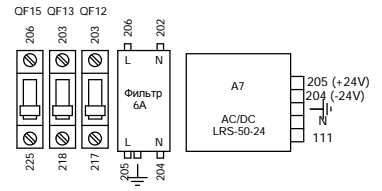
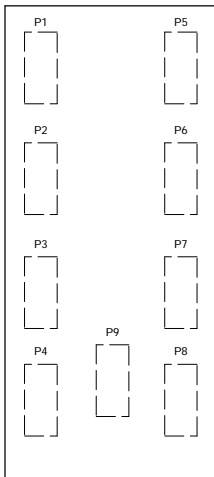

- XT1
- 102
- 103
- 104
- 105
- 106
- 107
- 108
- 109
- 110
- 111

- XT2
- 112
- 113
- 114
- 115
- 116
- 117
- 118
- 119
- 120

- XT3
- 124
- 1
- 2
- 3
- 4
- 5
- 6
- 8
- 9
- 33

- XT4
- 18
- 19
- 21
- 22
- 32
- 640
- 200
- 200
- 225
- 223

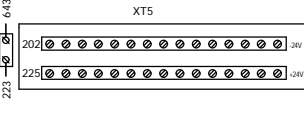

- XT6
- 202
- 202
- 225
- 225
- 4852
- 4851
- 319
- 209
- 225
- 4853
- 4854

- XT7
- 202
- 225
- 4852
- 4851
- 221
- 224
- 72
- 54
- 132 (K4-1)
- N

- XT8
- U5
- V5
- U6
- V6
- U7
- V7
- W7
- 140
- N
- N
- N

Клемная колодка шкафа управления