

К автоматическим выключателям нагревателей

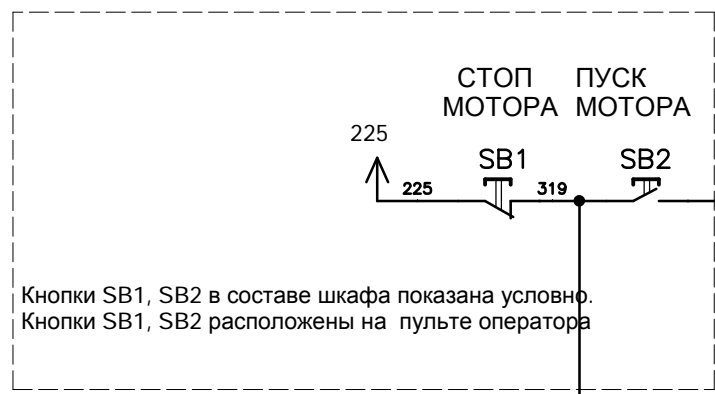

Кнопки SB1, SB2 в составе шкафа показана условно. Кнопки SB1, SB2 расположены на пульте оператора

на конт. 3 разъема P2 блока входов-выходов

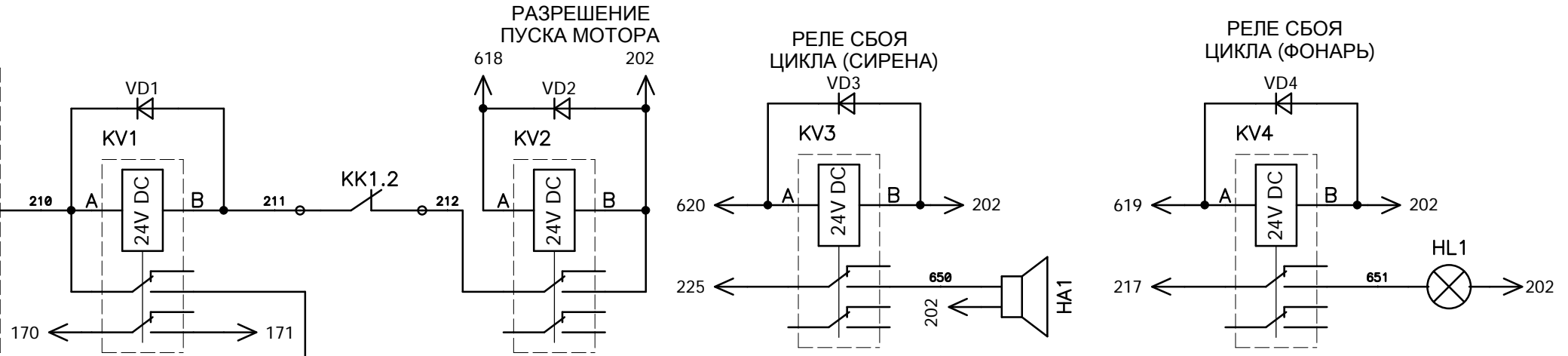

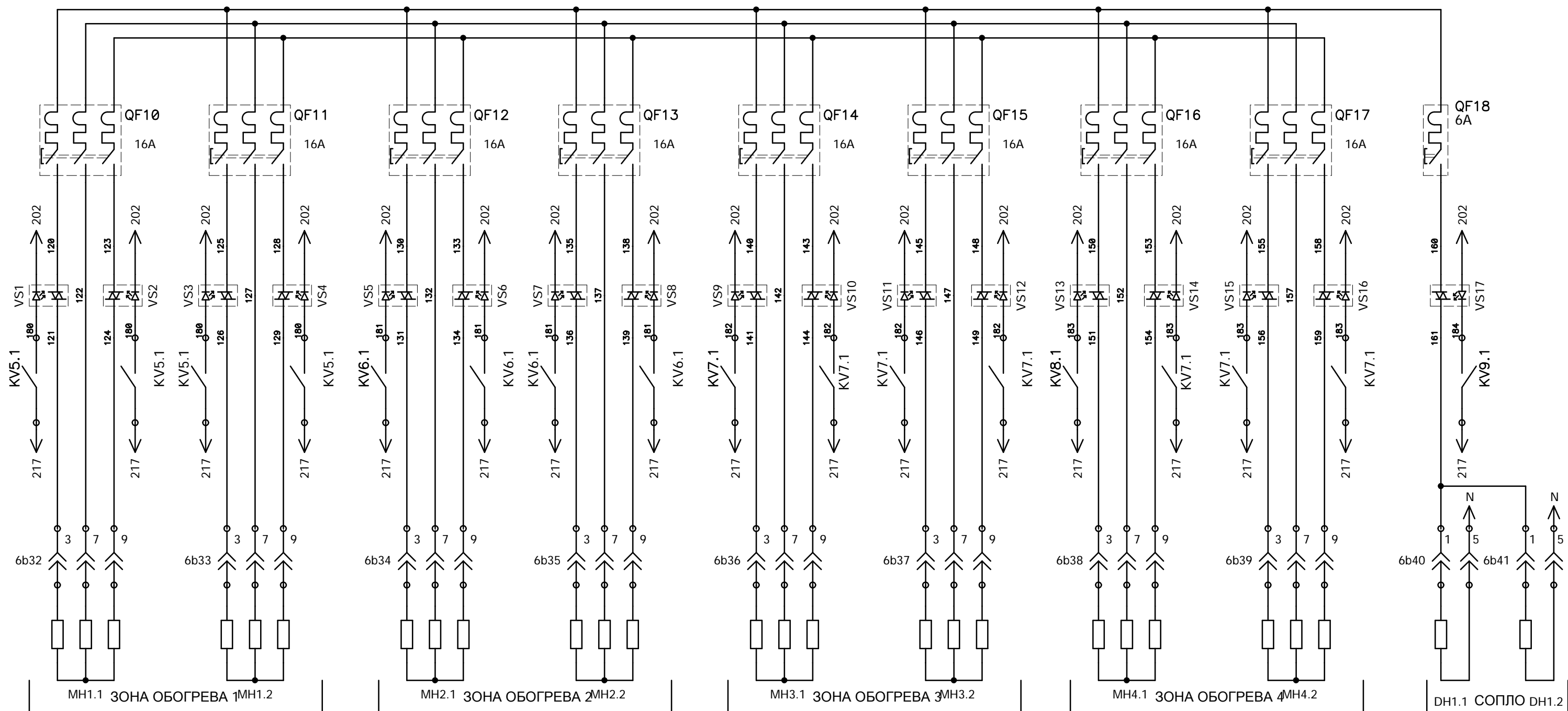

ЗОНА ОБОГРЕВА 1  
KV5

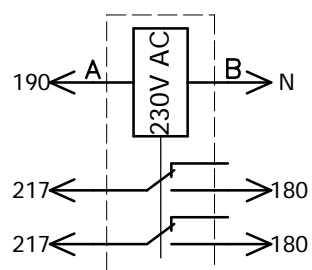

ЗОНА ОБОГРЕВА 2  
KV6

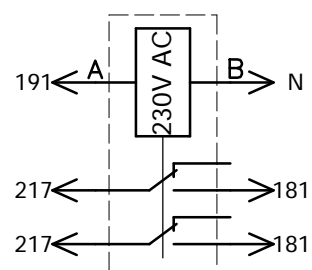

ЗОНА ОБОГРЕВА 3  
KV7

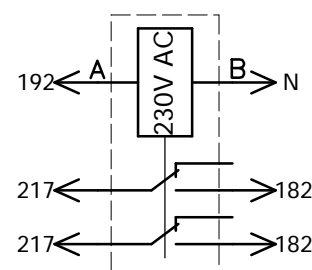

ЗОНА ОБОГРЕВА 4  
KV8

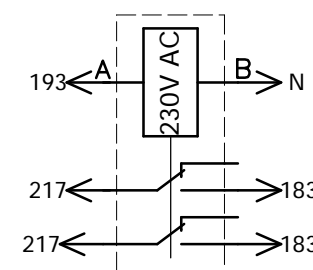

СОПЛО  
KV9

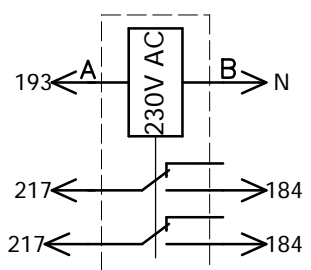

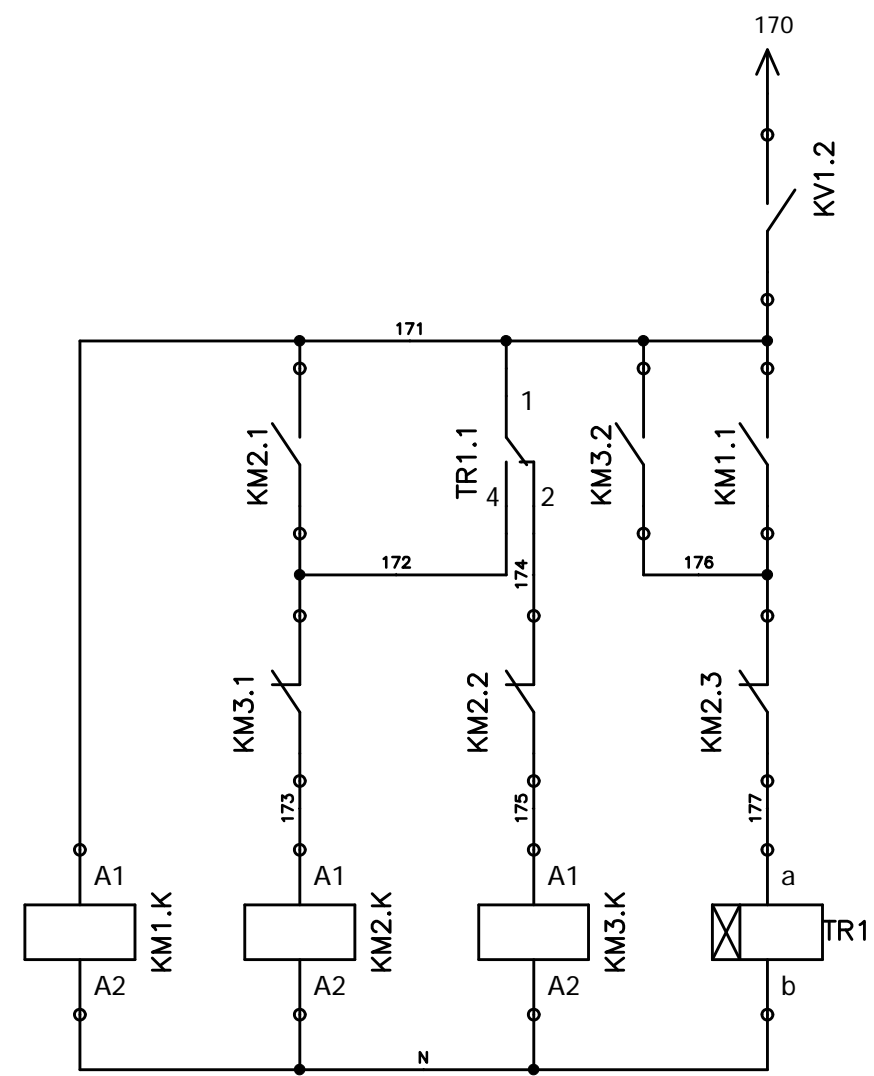
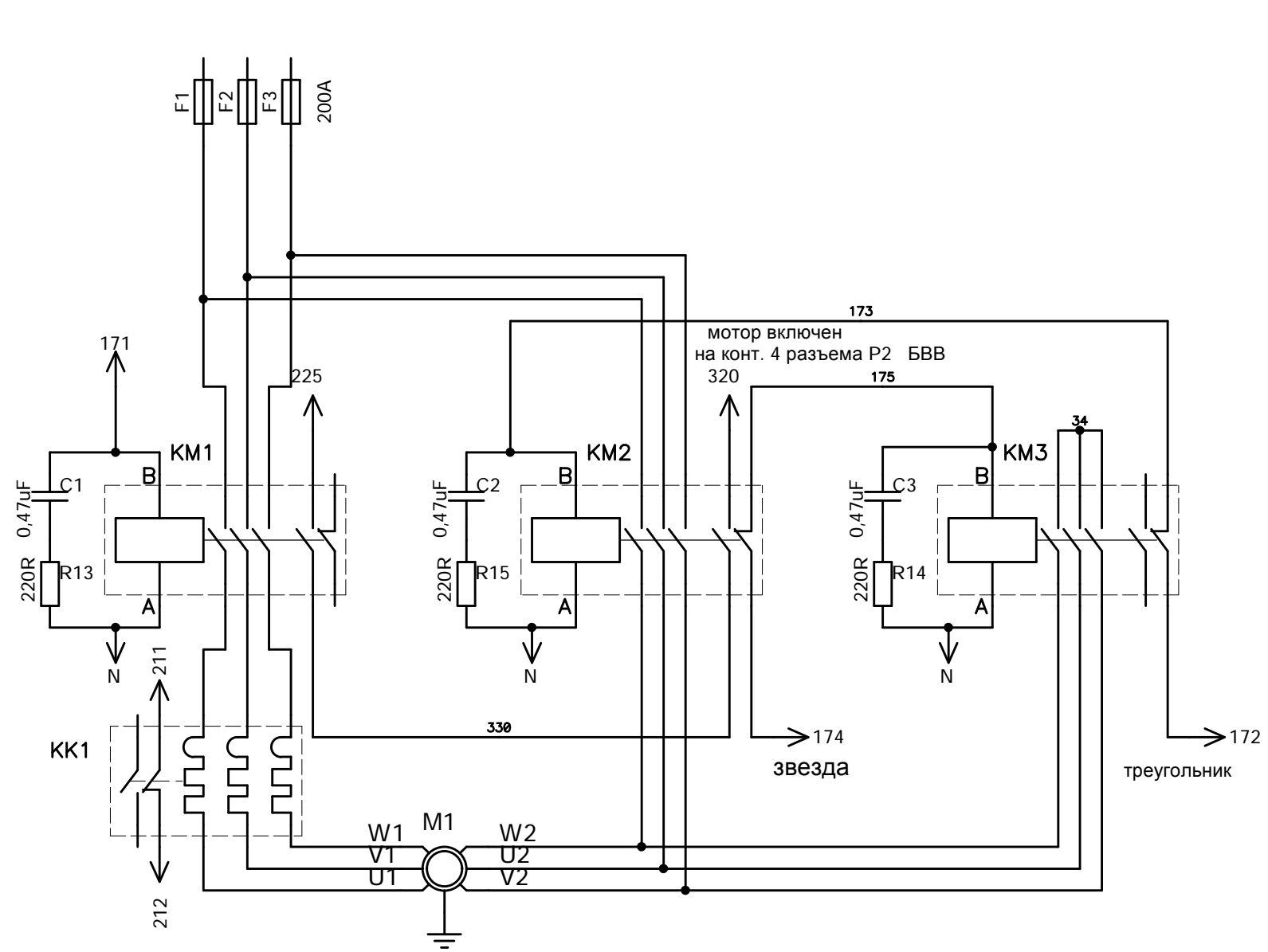

БЛОК  
ВВОДА-ВЫВОДА  
(БВВ)

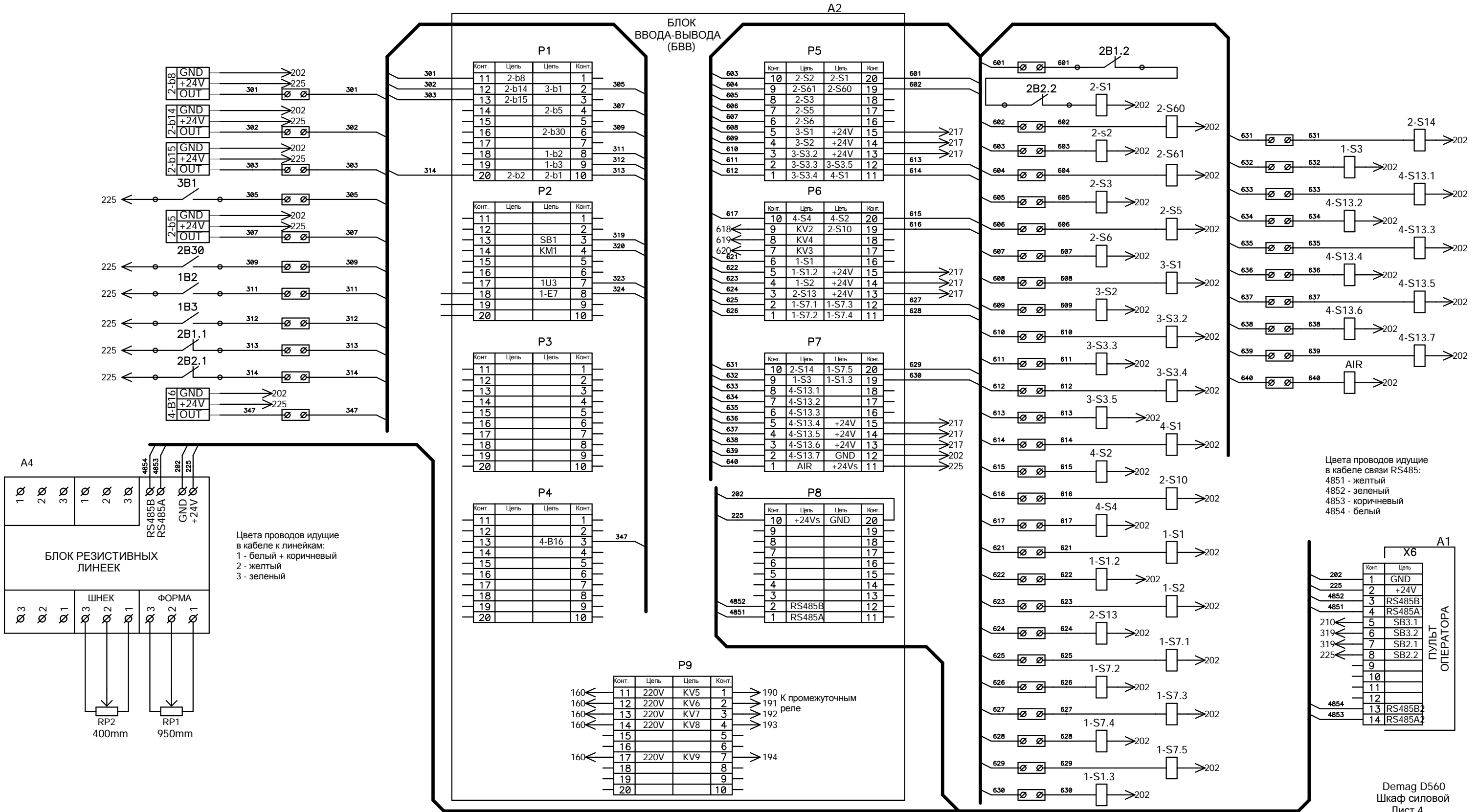

Цвета проводов идущие в кабеле к линейкам:  
1 - белый + коричневый  
2 - желтый  
3 - зеленый

Цвета проводов идущие в кабеле связи RS485:  
4851 - желтый  
4852 - зеленый  
4853 - коричневый  
4854 - белый

